



GRIN[®]

CHANGE YOUR PERSPECTIVE

CATALOGUE

2023

www.mygrin.eu



#changeyourperspective

GRIN was founded in 2005 to change the perspective of garden maintenance.

The creation and the development of our products have a common philosophy as guideline:

- To improve the quality of life
- To innovate and simplify
- To propose sustainable solutions

Discover the GRIN R-evolution !



CHANGE YOUR PERSPECTIVE

GRIN GUARANTEES



20
Models

aimed to meet your every need.



750
Authorised dealers

to advise and help you.



80.000
Satisfied customers

who use GRIN lawn mowers.



Check out the pictures of the gardens mowed with GRIN and read the customer's reviews:

www.mygrin-garden.com

INDEX



1. GRIN R-EVOLUTION

- How it works p. 8
- The GRIN gardens p. 12
- Ask the expert | GRIN vs mulching p. 14
- Ask the expert | Leaves are transformed into fertilizer p. 16

2. THE GRIN ECO-FRIENDLY GARDEN

- The 3Rs of Sustainability p. 20

3. INNOVATION, SIMPLICITY, CONVENIENCE

- **HIGHLIGHTS | INNOVATION** p. 26
- Foldable handlebar
- Anti-vibration quick regulator
- Height adjustment lever
- Frame designed for transport
- Easy starter
- Electric starter

#changeyourperspective

4. PRODUCTS BUILT TO LAST

HIGHLIGHTS CONSTRUCTION	p. 30
• Mowing deck	
• Frame	
• Blade	
• Wheels	
• Traction	
• Axles	
• Engine protection cone	p. 32
• Briggs & Stratton engines	p. 34
• Kawasaki engines	p. 35

5. WE HELP YOU CHOOSING YOUR GRIN

• Selection guide	p. 38
• The full range	p. 40
• Ask the expert	p. 42

6. THE GRIN RANGE

• Lawn mowers - EM range	p. 46
• Lawn mowers - HM range	p. 50
• Lawn mowers - BM range	p. 66
• Lawn mowers - BRIGGS & STRATTON PM range	p. 76
• Lawn mowers - KAWASAKI PM range	p. 86
• Summary data sheet	p. 92
• Ride-on lawn mowers - RM range	p. 94
• Shredders - BIOCH range	p. 98

7. GRIN IS ALWAYS BY YOUR SIDE

• The GRIN company	p. 106
--------------------------	--------



1.

GRIN R-EVOLUTION

How it works •

The GRIN gardens •

Ask the expert |

GRIN vs mulching •

Ask the expert |

Leaves are transformed into fertilizer •



How it works



✓ IT PULVERISES GRASS

✓ IT MOWS TALL GRASS

✓ IT IMPROVES YOUR LAWN

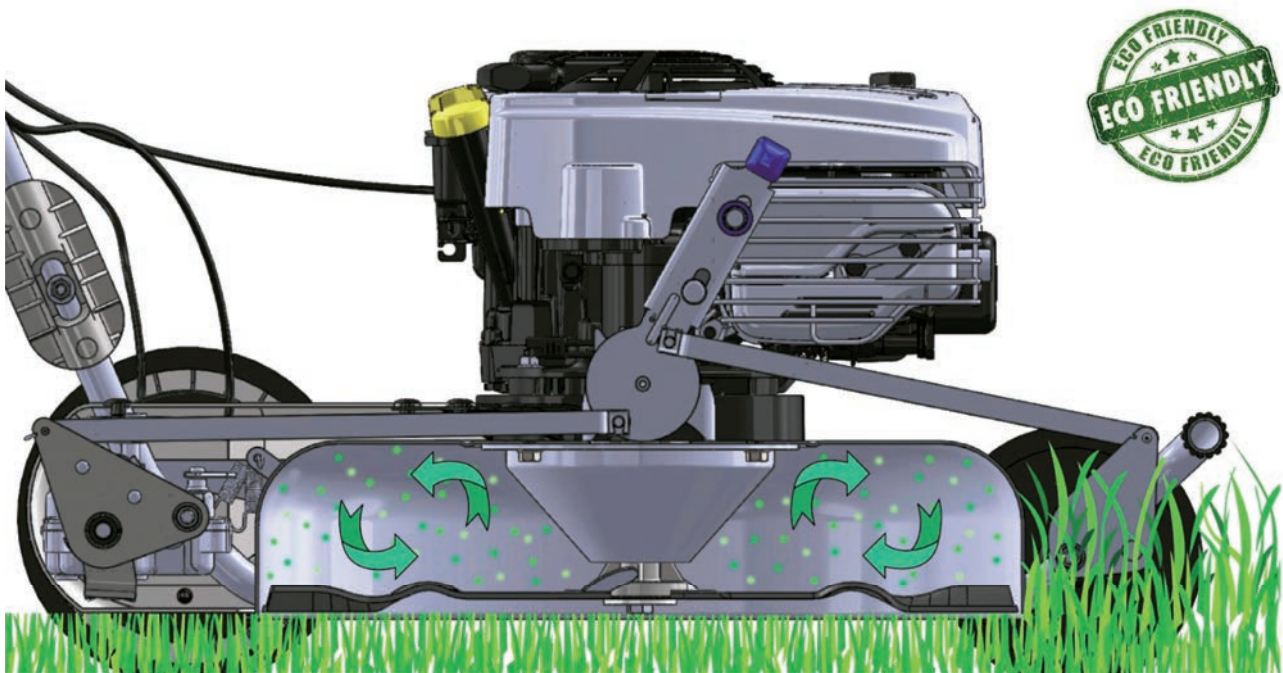

The patented mowing system - **MOWING, NO GRASS BAG, NO WASTE** - developed by GRIN pulverizes grass while mowing. With GRIN there is no need to collect the grass, store it and dispose of it.

The mowed grass remains suspended for a few fractions of a second inside the patented GRIN mowing deck. It is centrifuged and pulverized, thanks to the vortex created by the patented GRIN blade combined with the effect of a GRIN helix disc.

In this way the grass loses most of its volume and is pulverized into tiny little and virtually invisible particles. These particles fall directly onto the soil (they do not remain on the surface of the lawn!) and are absorbed in a very short time.

GRIN optimally processes the grass inside the mowing deck, pulverizing everything into extremely fine particles, which become an excellent fertilizer for your lawn!

Under normal conditions, the lawn looks identical to the one mowed with a mower with grass bag.

The mowing deck is so voluminous and smooth that no accumulation and clogging problems are encountered during mowing, which are typical of machines with grass bag, instead.

All GRIN mowers are built with a special frame, solely designed for this type of mowing. The GRIN frame optimizes the performance of the patented mowing system and ensures excellent results even in particularly difficult mowing conditions: tall grass, wet grass, uneven terrain etc.



FIND OUT MORE!

MOWING NO GRASS BAG NO WASTE



#changeyourperspective

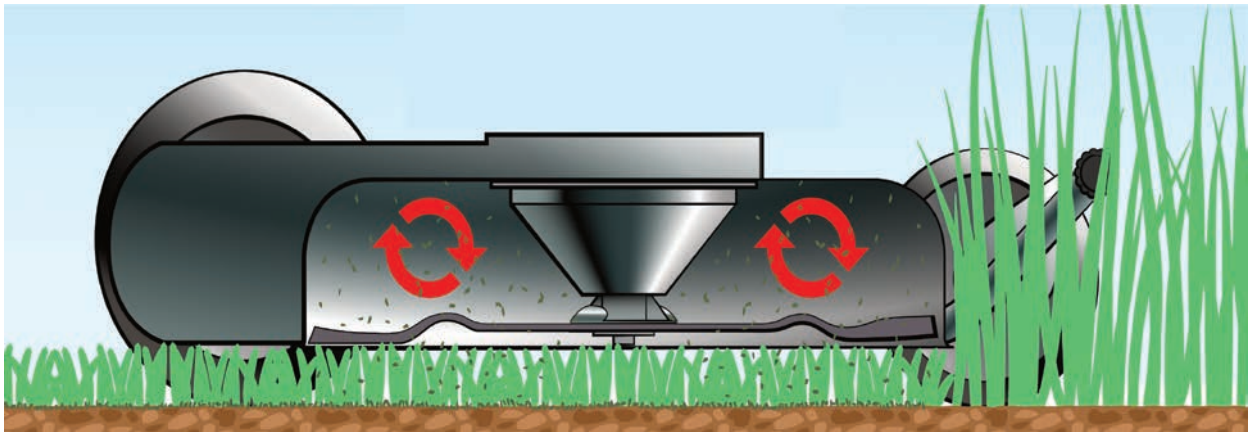

HOW IT WORKS

1. GRIN mows the grass and **PULVERIZES** it
2. The grass is absorbed as **FERTILIZER**
3. The **FERTILIZER** makes your lawn more beautiful!

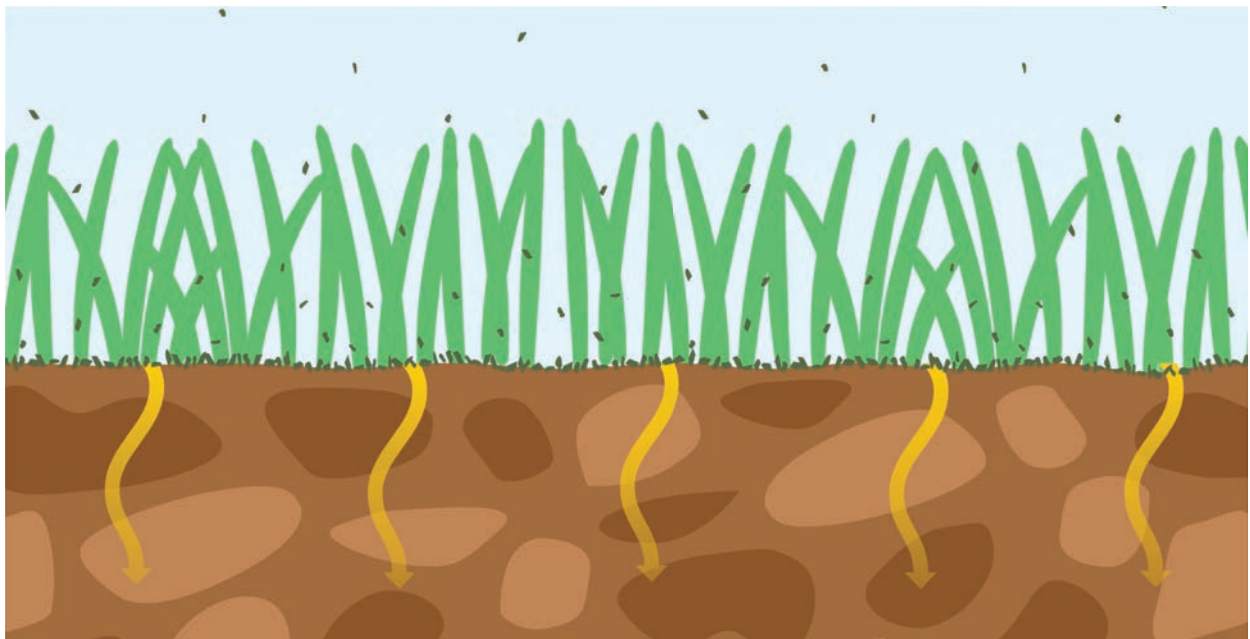

THE ADVANTAGES

1. Quicker and easier maintenance
2. No waste to be disposed of
3. Less weeds
4. Lower use of fertilizers and water

In any conditions... a perfect lawn!



**MOWING
NO GRASS BAG
NO WASTE**

MADE IN ITALY
PATENTED

#changeyourperspective



TEST DRIVE GRIN



✓ IT PULVERISES GRASS

✓ IT MOWS TALL GRASS

✓ IT IMPROVES YOUR LAWN

WOULD YOU LIKE TO TEST GRIN?



Contact us at :

+39.039.95.51.98



Find the closest dealer

www.mygrin.eu



Follow us and find out all the events



1. GRIN R-EVOLUTION



The GRIN gardens

CHECK OUT ALL THE PICTURES ON



www.mygrin-garden.com



Name: **Ginette**

Country: **The Netherlands**

Garden size: **400 m²**

GRIN model used: **EM37**

I LOVE GRIN BECAUSE:

"Acceptable noise level, mows well and light in use, easy to move around and reduces the grass in fine particles (extra nutrition for the lawn). Delivers what it promises."

MY OPINION ON GRIN



Name: **Fabio**

Country: **Italy**

Garden size: **700 m²**

GRIN model used: **BM46**

I LOVE GRIN BECAUSE:

"Powerful, quiet and very fast."

MY OPINION ON GRIN



Name: **Thierry**

Country: **France**

Garden size: **1500 m²**

GRIN model used: **HM46A**

I LOVE GRIN BECAUSE:

"I no longer go to the dump, my garden became more beautiful etc."

MY OPINION ON GRIN



80.000 customers have chosen GRIN mowing system



Name: **Benedetta**
Country: **Italy**
Garden size: **3000 m²**
GRIN model used: **PM53A**

I LOVE GRIN BECAUSE:

**"It's a fantastic machine!
I mow my garden in a very short
time. Mowing is a pleasure now.
Thank you GRIN!"**

MY OPINION ON GRIN

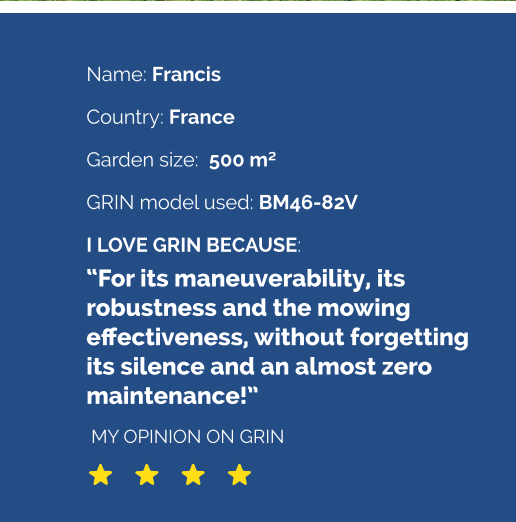

Name: **Francis**
Country: **France**
Garden size: **500 m²**
GRIN model used: **BM46-82V**

I LOVE GRIN BECAUSE:

**"For its maneuverability, its
robustness and the mowing
effectiveness, without forgetting
its silence and an almost zero
maintenance!"**

MY OPINION ON GRIN



Name: **Jean-Pascal**
Country: **France**
Garden size: **2500 m²**
GRIN model used: **PM53**

I LOVE GRIN BECAUSE:

**" Ideal to mow leaves in
autumn and especially to
not go to the dump in
summer!"**

MY OPINION ON GRIN





Ask the expert



WATCH ALL THE TECHNICAL VIDEOS
ON GRIN YOUTUBE CHANNEL

• DOES GRIN DAMAGE THE LAWN?

NO. GRIN pulverizes grass into very fine particles, which do not remain on the surface of the lawn damaging it. Instead they fall directly onto the soil ready to be absorbed as fertilizer. **Both professionals and private users have been using GRIN for many years to maintain gardens.**

• WHAT HAPPENS TO THE PULVERIZED GRASS BY GRIN?

IT BECOMES A FERTILIZER. The grass pulverized by GRIN is absorbed by the soil thanks to the microorganisms and humidity. The nutrient-rich grass becomes a natural and valuable fertilizer for the lawn. **Being composed of 80% water, grass releases moisture, reducing the water supply needed for your lawn by 20%.**

• HOW TALL SHOULD BE THE GRASS TO BE MOWED BY GRIN?

IT IS NOT NECESSARY TO MOW MORE OFTEN. With GRIN there is no need to mow more often than with a mower with grass bag. Mowing heights do not change much, as well. To optimize grass pulverization, mow medium tall grass every 10-15 days. **GRIN is also effective in tall grass (over 20/30 cm), even if the pulverization is less fine.**

• CAN I MOW ALL TYPE OF GARDENS WITH GRIN?

YES. GRIN is suitable for both well-maintained and rustic lawns. On the website www.mygrin-garden.com you can find some pictures of gardens maintained with GRIN and notice the effectiveness of GRIN on the different type of lawns. **In case of doubts, contact one of our dealers to perform a free TEST-DRIVE.**

• IS THE GRIN MOWING SYSTEM DIFFERENT FROM THE TRADITIONAL MULCHING?

YES, THEY ARE VERY DIFFERENT. Both systems are characterized by mowing without grass bag, **but GRIN has many advantages:**

- **PULVERIZATION of grass**, without leaving large residues on the lawn surface, **which can hardly be absorbed.**
- **Mowing of TALLER GRASS**, without therefore being obliged to mow too often.
- **Effectiveness** even in case of **WET GRASS.**

THESE FEATURES ARE ESSENTIAL, WHERE CLIMATIC CONDITIONS FAVOR A RAPID GROWTH OF GRASS LIKE IN EUROPE.

GRIN vs MULCHING



WATCH THE VIDEO
GRIN vs MULCHING

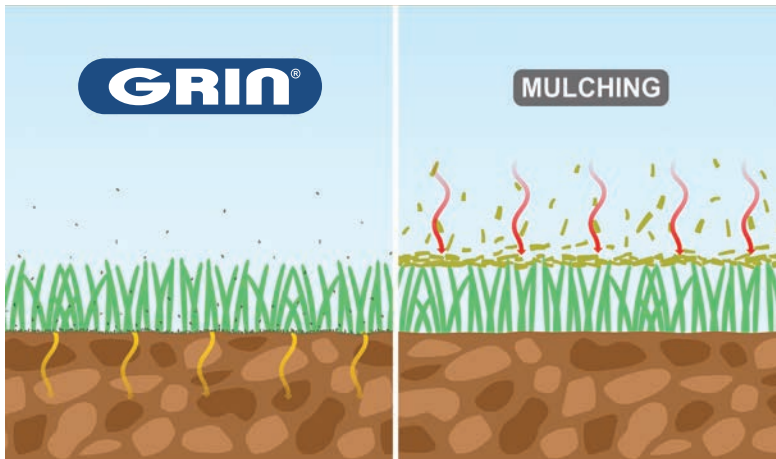

• YOU CAN'T SEE THE PULVERIZED GRASS ON TOP OF THE LAWN

Under normal mowing conditions, GRIN pulverizes grass so fine that it falls through the grass directly onto the soil, to be absorbed as natural fertilizer. In this way, the aesthetic result of mowing with GRIN is similar to the one obtained with a mower with grass-bag. Under similar mowing conditions, conventional mulching merely cuts grass, which remains on the surface of the lawn, making absorption by the soil difficult. **The risk of grass accumulation and lawn suffocation is therefore very high.** Moreover, when it dries up, it remains visible on top of the lawn, looking unaesthetic.

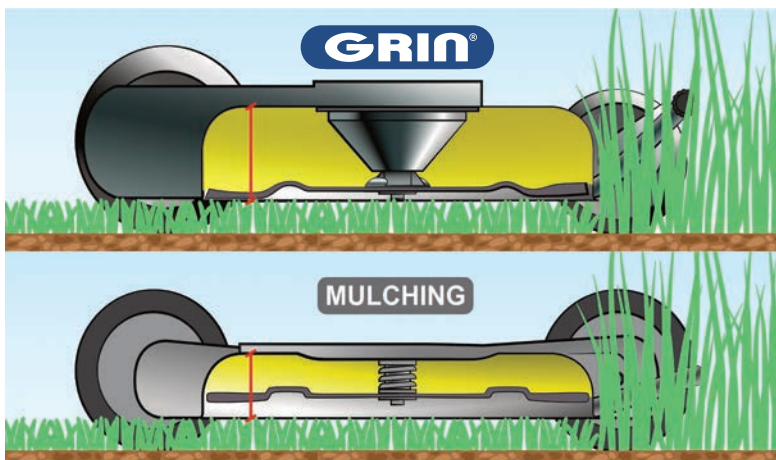

• THE GRIN MOWING DECK MOWS ALSO TALL GRASS

The GRIN mowing deck is about 30% higher than conventional mulching machines. The shape and the position of the blade make the volume of a GRIN mowing deck about 50% larger than conventional mulching machines. This means that a GRIN mower can mow more grass and for a longer period, without getting overloaded. **Therefore, GRIN performs much better in medium-tall grass than a conventional mulching system.**

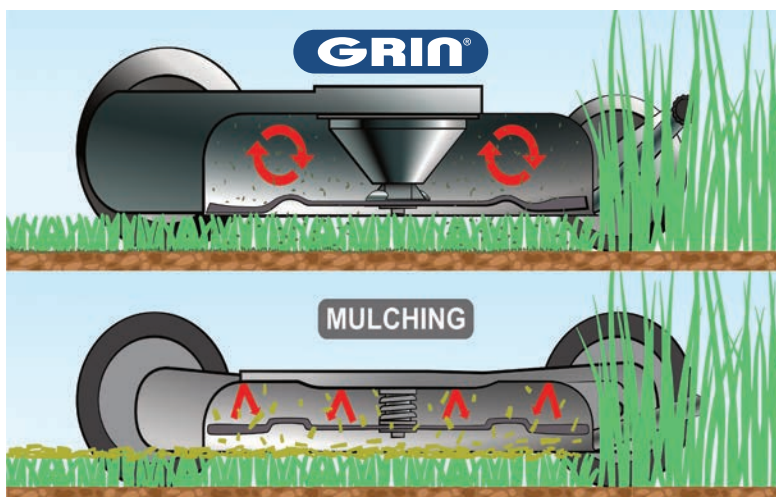

• THE GRIN BLADE CENTRIFUGES THE MOWED GRASS

The GRIN mowing system consists of a patented blade with a particular shape and made of a special material. The blade is assembled with a patented helix disc in a specific position inside the mowing deck. These two components, combined with the shape of the mowing deck, create a vortex with centrifugal effect, which keeps the grass suspended in air for a long time to be pulverised in fine particles.

The mowing system of a mulching machine normally consists of a curved blade that cuts the grass into several segments, the first time during mowing and then when the cut segment falls down. When the length of the grass to mow exceeds 8-10 cm, the cut segments remain long and visible.



Ask the expert



WATCH THE VIDEO OF
GRIN ON LEAVES



• Leaves are transformed into fertilizer.

The patented mowing system – MOWING, NO GRASS BAG, NO WASTE – developed by GRIN is also effective with leaves. The leaves are ground inside the mowing deck and transformed into fertilizer for your lawn.

If the leaves are fine ground by the GRIN system, they become an excellent nourishment for the lawn because they are rich of carbon. The night humidity and the microorganisms of the terrain help the absorption, so that the soil becomes more fertile and consequently more beautiful.

In this way, there is no need to waste time and effort in collecting the leaves and disposing of them.



DEMO DAY GRIN

✓ MEET GRIN TECHNICIANS

✓ FIND OUT THE SECRETS OF THE MOWING SYSTEM

✓ FIND THE RIGHT MODEL FOR YOUR GARDEN



FIND OUT THE GRIN EVENTS AND JOIN US!

www.mygrin.eu



FIND OUT MORE!



2.

THE GRIN ECO-FRIENDLY GARDEN

Save time and effort

The 3Rs of Sustainability •



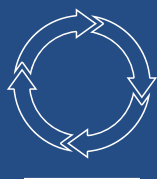

The 3Rs of Sustainability



Recycle | Reuse | Reduce



RECYCLE grass to transform it into fertilizer.

The recycling of the grass pulverized by the GRIN mowing system allows the transformation of "waste" into a valuable fertilizer that increases the presence of the organic substance in the soil: humus.

Humus is one of the key element to create a stable and fertile soil able to easily release nutrients and balance the presence of air and water.

The grass pulverization avoids its transport to the waste disposal that, apart of being tiring and annoying, implies the use of motorized vehicles, which are often polluting, and causes an expensive waste management for the community.

You can therefore save time and effort.



REUSE the pruning as chippings.

With the GRIN shredders, you can chop hedges, trees and bushes, obtaining useful chippings for ground covering or to mix it with the soil.

The chipping: when it decomposes, it becomes an excellent, natural fertilizer that serves as water reserve and helps protect from the drought, reducing in this way water needs. It limits the growth of weeds and therefore the weeding. It also protects the soil from the atmospheric agents, thermal stress and erosion.

Reusing pruning as chippings avoids having to dispose of it and you will therefore save time and money.



REDUCE the use of water and chemical fertilizers.

The combined action of the GRIN cutting system for grass and pruning allows a significant reduction of water and fertilizer.

Water is a precious (and expensive resource) that must be saved. However, plants and lawn need it to grow lush.

Thanks to a GRIN garden maintenance, it is possible to minimize irrigation, using the humidity contained into the grass blades pulverized by the lawn mowers and keeping the soil humid with the chippings under hedges and plants.

Besides water, the lawn, the hedges and the plants need fertilizers to grow healthy.

Again, the combined action of the GRIN cutting system allows to feed the microorganisms of the soil, providing a natural and free fertilizer, that reduces or, in some cases, eliminates the use of other chemical fertilizers.



REDUCE | REUSE | RECYCLE

ECO-FRIENDLY GARDEN





Save time and effort.

WOULD YOU LIKE TO TEST GRIN?

 **TESTDRIVE** 

Contact us at :
+39.039.95.51.98

Find the closest dealer
www.mygrin.eu

Follow us and find out all the events
 





3.

INNOVATION SIMPLICITY CONVENIENCE

HIGHLIGHTS | INNOVATION

- Foldable handlebar •
- Anti-vibration quick regulator •
- Height adjustment lever •
- Frame designed for transport •
- Easy starter •
- Electric starter •



Highlights



INNOVATION

01. FOLDABLE HANDLEBAR



02. ANTI-VIBRATION QUICK REGULATOR



03. CENTRALIZED MOWING HEIGHT ADJUSTMENT



INNOVATION, SIMPLICITY, CONVENIENCE

04. FRAME DESIGNED FOR TRANSPORT



05. EASY STARTER



06. ELECTRIC STARTER



01. FOLDABLE HANDLEBAR

Thanks to two easy levers, it is possible to fold the handlebar for storage in little space and an easy transport. With folded handlebar, GRIN can be put vertically to clean the mowing deck or to be stored in garage*.

*The electric models and the models equipped with MOW N' STOW combustion engine can be stored vertically for a long period (even with full tanks)

02. ANTI-VIBRATION QUICK REGULATOR

Two sturdy Nylon regulators allow the adjustment of the handlebar height according to the one of the user. GRIN has also studied a vibration absorption system inside the new regulators to grant much more comfort in case of intensive use.

03. CENTRALIZED MOWING HEIGHT ADJUSTMENT

The rapid height adjustment on the four wheels is possible using a single lever. With a single movement, it is possible to set the desired height quickly and easily.

04. FRAME DESIGNED FOR TRANSPORT

The GRIN frame has an ergonomic shape designed to improve the maneuverability of the mower and is suitable for transport. Two handles allow the user to lift the machine easily in case of stairs or inconvenient areas of the garden. With folded handlebar, GRIN can also fit in the smaller cars to be easily transported.

05. EASY STARTER

The high range equipment of the GRIN motors allow an effortless and immediate start. New technologies make the use easy and intuitive by minimizing ordinary maintenance operations.

06. ELECTRIC STARTER

Just a button is necessary to start the GRIN models with combustion engine of the INSTART range and the electric ones of the EM and BM range. A simple press of the starter is enough to be ready to mow: quick, easy and effective.





4.

PRODUCTS BUILT TO LAST

HIGHLIGHTS | CONSTRUCTION

Mowing deck •

Frame •

Blade •

Wheels •

Traction •

Axles •

Engine protection cone •

Briggs & Stratton engines •

Kawasaki engines •



Highlights



CONSTRUCTION

01. STEEL MOWING DECK



02. STEEL FRAME



03. PATENTED BLADE



PRODUCTS BUILT TO LAST

04. STEEL WHEELS



05. SUSPENDED TRACTION



06. REINFORCED AXLES

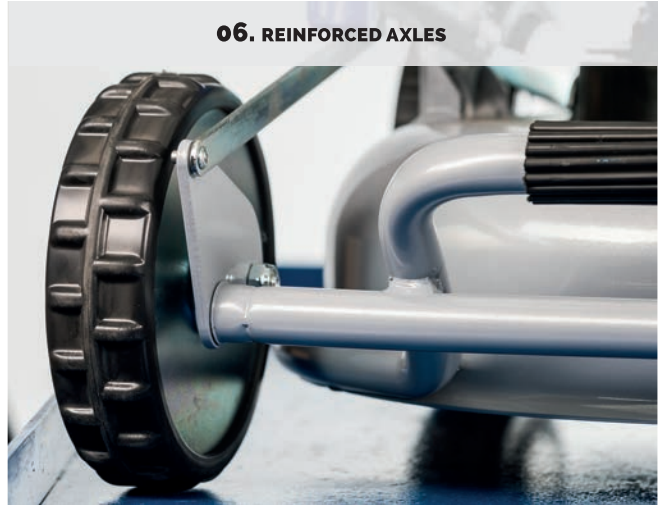

01. STEEL MOWING DECK

The mowing deck is completely smooth and manufactured with a 3 mm thick, powder coated steel.

This provides sturdiness and allows a proper centrifuge of the grass.

02. STEEL FRAME

The supporting frame is manufactured with a steel tube, which is welded to the mowing deck to form a unique solid part (registered utility model).

This increases the overall strength and rigidity of the lawnmower and helps reducing vibration.

03. PATENTED BLADE

The patented blade is manufactured with a special production process, which enhances strength and durability.

The material thickness and the sharpening method assure a 3/4 times longer life span than conventional blades.

04. STEEL WHEELS

The wheels with steel rim and hub are manufactured to last over time.

The double ball bearings grant ease of movement even on extremely difficult terrain. The treads have been designed to meet the need of every model and user.

05. SUSPENDED TRACTION

The traction in oil bath in aluminum casing works in suspension reducing the load on the drive axles.

The drive belt is completely protected by a specific cover. It tends automatically with the movement of the traction, thus minimizing the wear.

06. REINFORCED AXLES

The steel axles are characterized by sections of reinforced tube to grant impact resistance and an efficient mowing even after years of use.

Engine protection cone



WATCH THE VIDEO OF
THE ENGINE PROTECTION
CONE SYSTEM

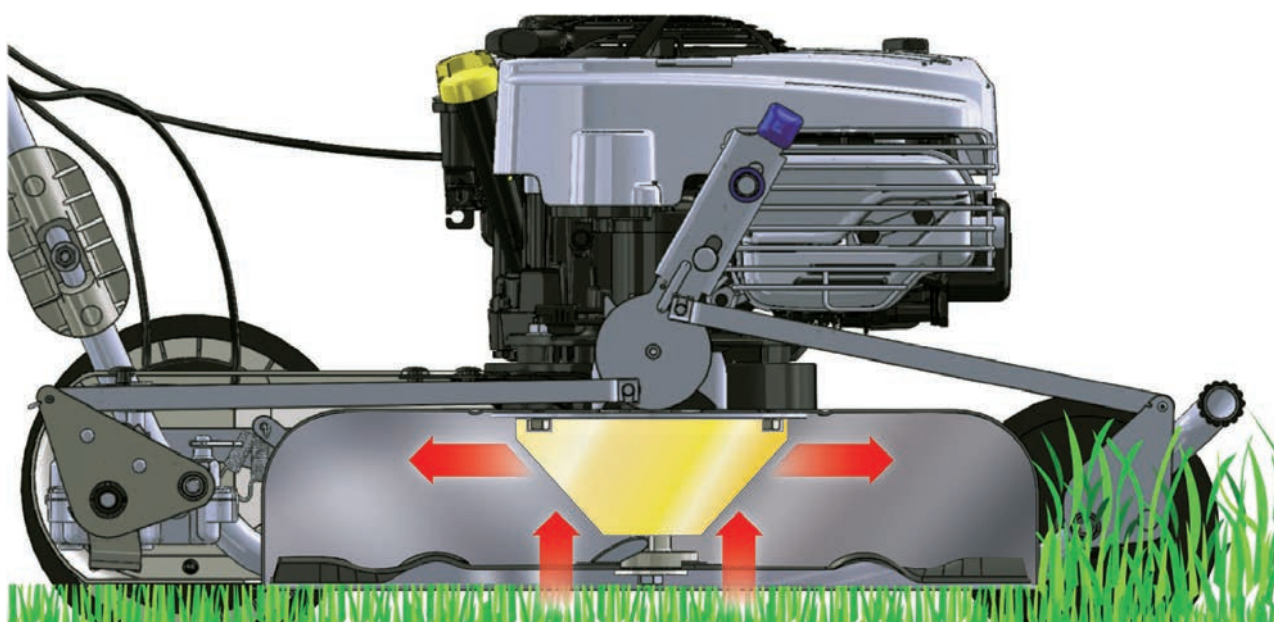

THE **ENGINE PROTECTION CONE** OFFERS PROTECTION WHEN THE BLADE ACCIDENTALLY HITS AN OBSTACLE WHILE MOWING (SUCH AS A STONE, ROOT OR OTHER).

Have you ever hit a stone with your lawn mower and damaged the crankshaft?

These kind of accidents may cause serious mechanical problems. For this reason, **GRIN has introduced a device called ENGINE PROTECTION CONE to minimize these risks.**

This device offers protection when the blade accidentally hits an obstacle while mowing (such as a stone, a root or something else). To better understand how it works, we suggest you watch the explanatory video.

The steel cone, in combination with the GRIN chassis, absorbs the hit and minimizes the risks of damage. Should the blade hub break, its replacement is easy, quick and low-cost. The user can directly carry it out.

The ENGINE PROTECTION CONE is recommended for uneven terrains or for any distracted user, who easily runs into this kind of accidents.

The ENGINE PROTECTION CONE is fitted as standard on the GRIN Professional range* and is optionally available for the other models.

* PM46A, PM53A, PM46A IS, PM53A IS, PM53A KW, SPM53A KW, BM46-82V, BM46A-82V



GRIN GIVES YOU FOR FREE THE **GUARANTEE
EXTENSION UP TO 3 YEARS.**

Register your Grin on www.mygrin.eu



FIND OUT MORE!

Briggs & Stratton engines



The American company Briggs & Stratton is the world-leading manufacturer of combustion engine for lawn mowers and other gardening and industrial applications. With over 100 years of history, Briggs & Stratton offers a dense, worldwide network of technical support with more than 40.000 workshops and authorized dealers.

In the last years, the Briggs & Stratton engines fitted on the GRIN lawn mowers have revolutionized the market by introducing some user-friendly technical innovations. In particular the systems Ready Start, IS Instart, Mow n' Stow and the brand new 82V lithium ion battery powered motor.



EXI SERIES ReadyStart



The EXi series engines offer the perfect combination of power, performance and ease of use. These engines feature the ReadyStart® system, which makes it extremely easy to start the engine.

Manually starting with a primer or air intake adjustment is no longer necessary. It is enough to pull the cord a couple of times and the motor starts right away.

*FITTED ON MODELS

HM37 / HM46 / HM46A / HM53A / PM46A / PM53A



IS INSTART



A conventional lawn mower is started up thousands of times by pulling the starter cord. GRIN machines equipped with the Briggs & Stratton engine with IS Instart system feature instead electric start-up with a push of a button. A lithium ion battery, fitted directly on the engine, assures immediate and effortless start. Charging the battery is simple and easy, thanks to an external battery charger.

*FITTED ON MODELS

HM46 IS / HM46A IS / HM53A IS / PM46A IS / PM53A IS



MOW N'STOW

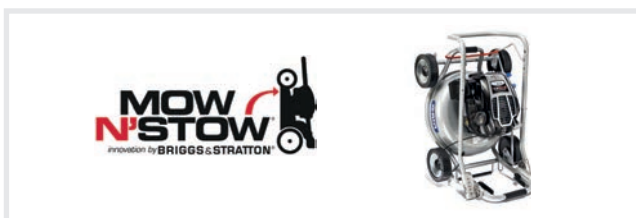

Thanks to the Mow N' Stow system, the lawnmower can be stored in vertical position after each use, thus saving the 70% of ground space and allowing an easy access to the mowing system.

These engines have specific technical features designed to avoid leaks of petrol and oil, when the lawnmower is put vertically.

*FITTED ON MODELS

HM37 / HM46 / HM46A / HM53A / HM46 IS / HM46A IS / HM53A IS



82V LITHIUM-ION



The brand new 82V Lithium-Ion battery powered motor combines the convenience and simplicity of an electric motor with the power of a combustion engine. Allowing an easier, more convenient and eco-friendly maintenance of your garden, this new technology marks a turning point in our industry.

*FITTED ON MODELS

BM37-82V / BM46-82V / BM46A-82V

Kawasaki engines

Powered by
Kawasaki

Kawasaki Engines has been producing professional engines for turf care for over 60 years.

With an engineering heritage firmly **focused on excellence and innovation**, Kawasaki Engines have earned a reputation for supplying some of **the highest quality and most dependable engines in the world**.



The FJ180V KAI engine with pressurised lubrication to mow on slopes is fitted on the models GRIN PM53A KW and SPM53A KW.

WHY DID WE CHOOSE IT?

Designed for durability

Strength and resilience is built into every FJ engine. From the tough combined crankcase design to hard-wearing chrome plated piston rings and cast iron cylinder liners. **Quality bearings ensure high engine loads can be sustained for a longer period of time.** The tough metal shroud gives maximum protection and durability.

Exceptional reliability

Professionals can rely on a dependable start for every job thanks to the heavy duty recoil starter. For long-term reliable performance, air filters are dual element and high particle capture, and engine cooling systems are protected by the rotating chopper screen that prevents grass debris build-up.

Performance and productivity

Cut easily through tough grass thanks to the heavy-duty, high inertia flywheel. Uneven ground, variable angles and slopes are tackled easily and reliably due to our high-efficiency pressurised lubrication system. **A low noise fan and low tone muffler make long days more comfortable, boosting operator productivity.**

Decreased downtime

Kawasaki made air filters ultra-easy to access, no tools required, allowing operators to make simple maintenance checks on the job.





5.

WE HELP YOU CHOOSING YOUR GRIN

[Selection guide](#) ·

[The full range](#) ·

[Ask the expert](#) ·





Selection guide



GRIN offers a complete range of products that fit the requirements of every garden.

It's important to choose the right lawn mower: GRIN will accompany you for many years to come!

Remember that GRIN does not have a grass bag. This makes it lighter and more maneuverable than the lawn mowers you have used until today.

1 - CHOOSE THE RIGHT MOWING WIDTH

Usually, you can choose a smaller GRIN lawn mower in comparison to a model with grass bag (e.g. if you used a 53 cm mowing width, a 46 cm GRIN model might suit you). **The choice of a grass bag lawn mower with large dimensions is due to the fact that a larger grass bag reduces the number of stops when mowing. With GRIN, choosing a larger mowing width saves you approx. 10 minutes each 1.000 m², however, the smaller machines are more maneuverable especially in tight spaces.**

2 - CONSIDER IF YOU NEED A TRACTION

Lawn mowers with grass bag are typically heavier, especially when the bag is full of grass. **To easily maneuver them, the traction is needed starting from 400 m² or on slight slopes. GRIN machines without traction are more maneuverable, instead, especially in tight spaces.**

A walk-behind GRIN mower is recommended up to 800 m² and 10° of slope.

3 - CHOOSE THE RIGHT ENGINE

Grin lawn mowers with electric motor have the same structural features as the ones with combustion engine: the mowing result is particularly qualitative and under normal mowing circumstances practically identical to that of the line with internal combustion engines.

USE THE GUIDING SCHEME IN THE NEXT PAGE TO CHOOSE THE GRIN MODEL SUITABLE FOR YOU AND YOUR GARDEN!

• How big is your garden in square meters?

M ² OF THE GARDEN	BLADE WIDTH	TRACTION	MODEL
0-400	37 cm (600-800 m ² \h)	NO	EM37 - HM37 BM37
400-800	46 cm (800-1.000 m ² \h)	NO	HM46 - HM46 IS BM46
800-1.200	46 cm (800-1.000 m ² \h)	YES	HM46A - HM46A IS BM46A PM46A - PM46A IS
1.200-3000	53 cm (1.000-1.200 m ² \h) (2.000 m ² \h with SPM53A)	YES	HM53A - HM53A IS PM53A - PM53A IS PM53A KW - SPM53A KW

COMPARISON WITH A LAWN MOWER WITH GRASS BAG

M ² OF THE GARDEN	GRIN BLADE WIDTH	LAWN MOWER WITH GRASS BAG BLADE WIDTH	GRIN TRACTION	LAWN MOWER WITH GRASS BAG TRACTION
0-400	37 cm	46 cm	NO	NO
400-800	46 cm	53 cm	NO	YES
800-1.200	46 cm	53 cm	YES	YES
1.200-3000	53 cm	53 cm	YES	YES

• Is it flat or on slopes?

DEGREE OF SLOPE	TRACTION	ENGINE
0° - 10°	NO (up to 800 M ²)	ALL
10° - 20°	YES	ALL
> 20° (MAX 35° - 40°)	YES	Battery (BM46A-82V) Kawasaki with pressurised lubrication (PM53A KW - SPM53A KW)

The full range



Hobby PRO

The HobbyPRO line is addressed to **demanding private users**. Robustness and quality of professional materials are combined with components designed to grant **maneuverability, convenience and ease of use**.

LIGHT

Designed to be maneuverable, even in tight spaces

EASY

Easy start and intuitive use

ROBUST

Professional frame, blade and wheels designed to last over time

RECOMMENDED FOR

HobbyPRO

0-400 M²



EM37



HM37



BM37-82V

400-800 M²



HM46



HM46 INSTART



BM46-82V

800-1.200 M²



HM46A



HM46A INSTART

1.200-3.000 M²



HM53A



HM53A INSTART



Corded electric



Internal combustion engine
Briggs & Stratton 6.75



Internal combustion engine
Briggs & Stratton 6.75

ELECTRIC START



Battery

82V

**MOWING
NO GRASS BAG
NO WASTE**

A model for every need

Professional

The PROFESSIONAL line is designed to professional turf maintenance. The components are suitable for intensive use, even on difficult terrains.

POWERFUL



Specific engine and components to mow under difficult conditions

RESISTANT



The engine protection cone is important on uneven terrain

ADAPTABLE



The professional traction allows you to adapt speed according to different mowing conditions

Professional BRIGGS & STRATTON

Professional KAWASAKI



SLOPES < 10°

SLOPES > 10°



BM46A-82V



PM46A



PM46A INSTART



PM53A



PM53A INSTART



PM53A KW



SPM53A KW

Battery

82V

Internal combustion engine
Briggs & Stratton 8.50

Internal combustion engine
Briggs & Stratton 8.50

ELECTRIC START

Internal combustion engine
Kawasaki

FOR SLOPES > 20°



Ask the expert



• HOW DO I CHOOSE THE RIGHT GRIN MODEL FOR MY GARDEN?

ACCORDING TO THE SIZE of your garden in square meters, choose the mowing width (37, 46 or 53 cm) referring to the chart at page 34. Once you have identified the models of the right size, look at the data sheets in the following pages: a rating scheme from 1 to 5 helps you finding the suitable product considering your mowing preferences.

Do not hesitate to contact GRIN for advice or visit one of our authorized dealers.

• FOR LAWNS UP TO 800 M², WHY ISN'T THE TRACTION NECESSARY WITH GRIN?

BECAUSE GRIN is lighter than a mower with grass bag. In fact it does not carry the weight of the bag full of grass. Unless there are slopes of more than 10°, the traction in a medium-sized garden could make the machine heavier and less maneuverable.

In order to understand more about the GRIN system, we suggest you to perform a free TEST DRIVE by our authorized dealers.

• WHICH IS THE DIFFERENCE BETWEEN GRIN PM AND HM PRODUCT RANGE?

The PM range is designed for PROFESSIONAL and very intensive use. The frame and the mowing deck are very similar in both product lines, but the equipment and the components are different. **The PM range in addition has the engine protection cone as standard, more performant engine, professional 2-speed traction, MAXI rear wheels, a more comfortable handlebar and levers.** As for the use, the main differences can be noticed on uneven terrains, in tall grass or on very well maintained lawns.

If you have doubts, do not hesitate to contact us for help or perform a free TEST DRIVE.

• HOW DO THE GRIN BATTERY MACHINES PERFORM?

LIKE THE ONES WITH COMBUSTION ENGINE.

The GRIN battery machines are equipped with the same steel frame like the ones with combustion engine.

The 82V motors are extremely powerful and grant excellent performances. The electric motor torque is sometimes even more performant than the engines of the HM range. Many professional use these machines also in very tall grass or on extremely difficult lawns. **You can fully appreciate it performing a free TEST DRIVE by the closest GRIN dealer.**

Keep up-to-date and find out all the news of GRIN world!

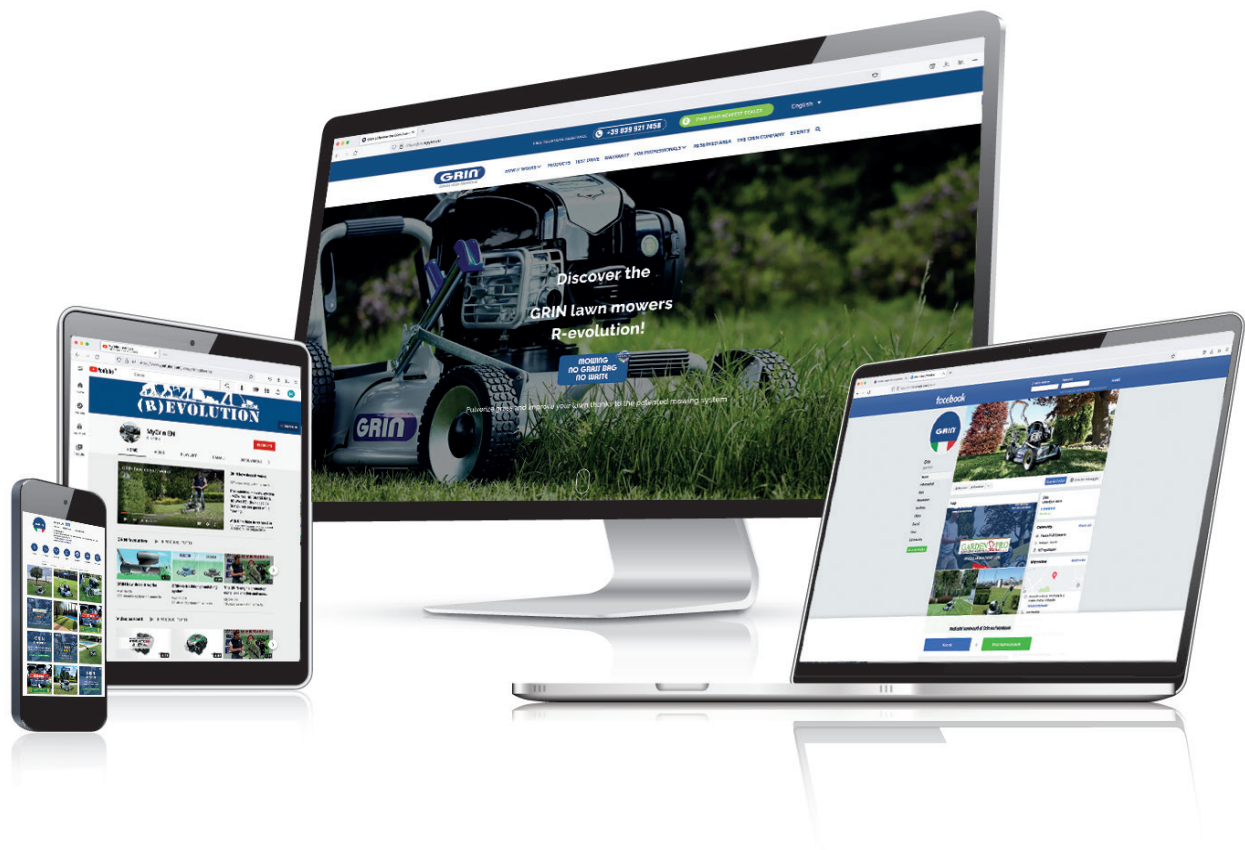

Get all the information on www.mygrin.eu
Find out more on our YouTube channel and
follow us on Facebook and Instagram!

www.mygrin.eu







6.

THE GRIN RANGE

EM range •

HM range •

BM range •

BRIGGS & STRATTON PM range •

KAWASAKI PM range •

Summary data sheet •

RM range •

BIOCH range •





EM range

CORDED ELECTRIC

HobbyPRO



The GRIN EM range consists of a mower with 37 cm mowing width featuring the patented MOWING – NO GRASS BAG – NO WASTE system.

Ideal for users who look for the convenience and simplicity of an electric motor without sacrificing the quality of the materials and the effectiveness of the GRIN mowing.

Recommended for those who need a maneuverable machine with steel frame and high quality mowing results.

It combines the same structural features of an internal combustion engine lawn mower with the silence, ease of use and reduced costs of an electric motor. It turns on with a practical command on the handlebar and the motor does not need any maintenance.

An electric mower like you have never seen before!

H I G H L I G H T S

01. ELECTRIC START



03. 1600 W ELECTRIC MOTOR



02. VERTICAL STORAGE



01. ELECTRIC START

Start the engine simply pushing a button.

02. VERTICAL STORAGE

70% of space saved in your garage.

03. 1600 W ELECTRIC MOTOR

The convenience of an electric motor, without giving up on performance.

EM range

GRIN EM37



FIND OUT MORE!

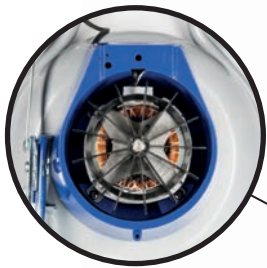

**MOWING
NO GRASS BAG
NO WASTE**

TESTDRIVE GRIN



Built on the proven GRIN chassis, Grin EM37 features a very powerful, 1600 Watt corded electric motor.

Those who have tried this machine confirm they have found **no differences in mowing quality compared to an internal combustion engine lawn mower.**

Very maneuverable thanks to the compact size and steel wheels with double ball bearings, **this lawn mower excels in gardens up to 400 m² with easy access to mains power sockets.**

The advantages of this model are: **silent, easy to switch on, no polluting emissions, the convenience of not needing any petrol or oil.**

The structure of this machine is the same as a GRIN lawn mower with internal combustion engine.

When used in a small garden, it will work perfectly for many years.



HM range

INTERNAL COMBUSTION ENGINE

HobbyPRO



The GRIN HM range consists of 7 lawn mowers featuring the patented MOWING – NO GRASS BAG – NO WASTE system.

They are powered by the Briggs & Stratton 6.75 series internal combustion engine, which is available with both starter cord and electric start.

Recommended for all demanding private users, who require a machine with a professional chassis that also assures great maneuverability.

They are available with mowing width of 37, 46 and 53 cm and either in the push version or with traction.

These were the first models to be developed with the patented MOWING - NO GRASS BAG - NO WASTE system.

They have always driven our company's growth; very reliable machines tested and evolved over 15 years in the field!

H I G H L I G H T S

01. READY START



02. ELECTRIC START



03. MOW N'STOW VERTICAL STORAGE



01. READY START

Automatic starter to start the engine on the first try.

02. ELECTRIC START

Start the engine simply pushing a button.

*on the INSTART machines

03. MOW N'STOW VERTICAL STORAGE

70% of space saved in your garage even with full tanks.

HM range

GRIN HM37



FIND OUT MORE!



MOWING
NO GRASS BAG
NO WASTE

TESTDRIVE GRIN

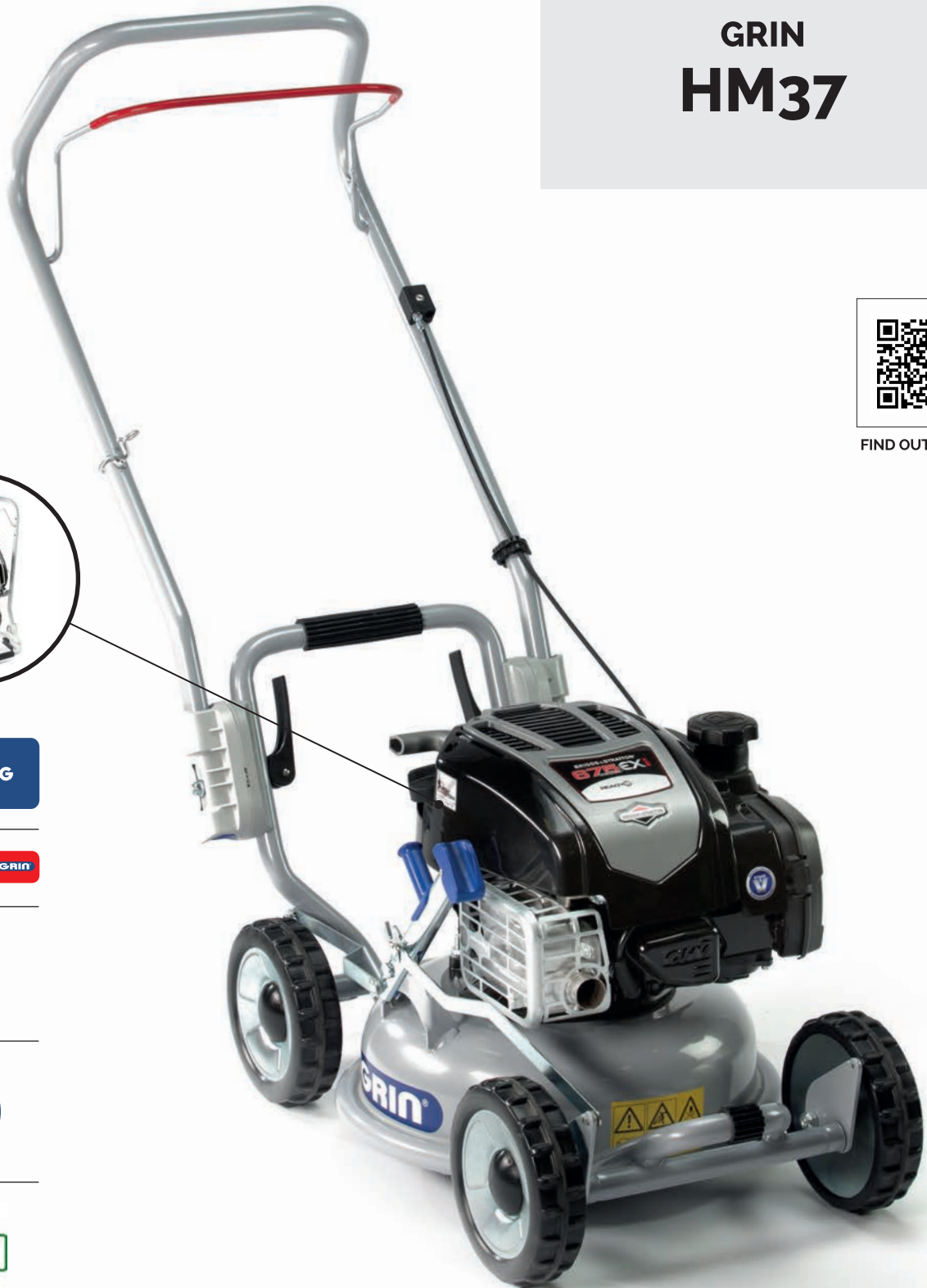

GRIN HM37 is a compact, very maneuverable lawn mower with internal combustion engine.

Built on the proven **GRIN chassis**, it is equipped with the powerful and reliable **Briggs & Stratton 675 series, 163 cc engine** with **Ready Start** for an easy start up.

This lawn mower is the smallest and lightest of the internal combustion engine range. Nevertheless, it features the structural advantages of all GRIN lawn mowers, granting high solidity and mowing efficiency: **3 mm thick mowing deck, reinforced by a tubular frame, steel wheels with double ball bearing, centralised height adjustment lever, quick anti-vibration handlebar regulators, 25 mm handlebar, patented GRIN blade, etc.**

Ideal for users who look for high quality mowing in small gardens or with narrow passages.

The 37 cm blade is recommended for lawns up to approximately 400 m². The chassis of this machine is very solid and durable. In case of particularly rocky or uneven terrain, it can be equipped with the optional engine protection cone.

GRIN HM46



FIND OUT MORE!



**MOWING
NO GRASS BAG
NO WASTE**

TESTDRIVE GRIN



GRIN HM46 is one of the most popular machines in the GRIN range with internal combustion engine.

Built on the proven GRIN chassis, it is equipped with the powerful and reliable Briggs & Stratton 675 series, 163 cc engine with READY START for an easy start up.

The most impressive feature of this lawn mower is its maneuverability. Its compact chassis, the wheels with double ball bearings, the low weight of 27 kg and the practical frame make it the ideal machine to easily mow in between trees, flowerbeds, lanes and all the other obstacles in the garden.

Nevertheless, its 46 cm mowing deck allow easy and quick maintenance up to 800 m².

The lack of traction is not perceived on flat lawns: GRIN lawn mowers have no grass bag, therefore the weight of the machine is low and does not increase with full grass bag.

Pushing GRIN HM46 is easy and comfortable for everyone and there is no traction that could hinder maneuvering.

The chassis of this machine is very solid and durable. In case of particularly rocky or uneven terrain, it can be equipped with the optional engine protection cone.

GRIN HM46 INSTART

ELECTRIC START



FIND OUT MORE!



MOWING
NO GRASS BAG
NO WASTE

TESTDRIVE GRIN



The **INSTART** series of the model HM46 features an electric starter.

Built on the proven **GRIN** chassis, it maintains all the HM46 features and is equipped with the powerful and reliable Briggs & Stratton 675 series, 163 cc engine with **INSTART** system.

This innovative engine is powered by a built-in Lithium Ion battery that allows you to start the machine without pulling the cord, but just by pushing on a button.

The built-in battery, which is fully charged in about 4 hours, allows up to 200 starts with one full charge.

While a partial charge of 10 minutes allows more than 10 starts.

INSTART is a true revolution in the field of lawn mower engines.

GRIN HM46A



FIND OUT MORE!



**MOWING
NO GRASS BAG
NO WASTE**

TESTDRIVE GRIN



GRIN HM46A is one of the most popular machines in the Grin range with internal combustion engine and traction.

Built on the proven **GRIN** chassis, it is equipped with the powerful and reliable Briggs & Stratton 675 series, 163 cc engine with **READY START** for an easy start up.

The traction in oil bath, in aluminum casing, is reliable and powerful.

The innovative **GRIN** design of the traction, mounted on **GRIN** suspended axles, enables to increase shock resistance and durability.

The **46 cm mowing deck** allows you to quickly mow up to **1200 m²**, still assuring extreme maneuverability even in the narrowest garden areas, on slopes and during transport.

The **chassis of this machine is very solid and durable**. In case of particularly rocky or uneven terrain, it can be equipped with the optional engine protection cone.

GRIN HM46A INSTART

ELECTRIC START



FIND OUT MORE!



MOWING
NO GRASS BAG
NO WASTE

TESTDRIVE GRIN



The **INSTART** series of the model HM46A features an electric starter.

Built on the proven **GRIN** chassis, it maintains all the HM46A features and is equipped with the powerful and reliable Briggs & Stratton 675 series, 163 cc engine with **INSTART** system.

This **innovative engine** is powered by a built-in Lithium Ion battery that allows you to start the machine without pulling the cord, but just by pushing on a button.

The built-in battery, which is fully charged in about 4 hours, allows up to 200 starts with one full charge.

While a partial charge of 10 minutes allows more than 10 starts.

INSTART is a true revolution in the field of lawn mower engines.

GRIN HM53A



FIND OUT MORE!



**MOWING
NO GRASS BAG
NO WASTE**

TESTDRIVE GRIN



GRIN HM53A with internal combustion engine and traction is designed for large spaces.

Built on the proven GRIN chassis, it is equipped with the powerful and reliable Briggs & Stratton 675 series, 163 cc engine with READY START for an easy start up.

The traction in oil bath, in aluminum casing, is reliable and powerful.

The innovative GRIN design of the traction, mounted on GRIN suspended axles, enables to increase shock resistance and durability.

The 53 cm mowing deck allows you to mow lawns larger than 1200 m².

Compared to the smaller model, with 46 cm mowing deck, it is best suited for wide open spaces, where a larger mowing width helps to save time for maintenance.

The chassis of this machine is very solid and durable. In case of particularly rocky or uneven terrain, it can be equipped with the optional engine protection cone.

GRIN HM53A INSTART

ELECTRIC START



FIND OUT MORE!



MOWING
NO GRASS BAG
NO WASTE

TESTDRIVE GRIN



The **INSTART** series of the model HM53A features an electric starter.

Built on the proven **GRIN** chassis, it maintains all the HM53A features and is equipped with the powerful and reliable Briggs & Stratton 675 series, 163 cc engine with **INSTART** system.

This innovative engine is powered by a built-in Lithium Ion battery that allows you to start the machine without pulling the cord, but just by pushing on a button.

The built-in battery, which is fully charged in about 4 hours, allows up to 200 starts with one full charge.

While a partial charge of 10 minutes allows more than 10 starts.

INSTART is a true revolution in the field of lawn mower engines.



BM range

82V BATTERY

HobbyPRO

Professional



The GRIN 82V battery powered range consists of 3 lawn mowers, 2 push models and 1 with traction, featuring the patented MOWING – NO GRASS BAG – NO WASTE system. They are equipped with the innovative, brushless Briggs & Stratton electric motor with an output of 1,5 kw and powered by a 82V lithium ion battery.

This new technology allows amazing performances compared to the past. In terms of power and mowing quality, these lawn mowers have nothing to envy to the ones with internal combustion engine.

With the 5Ah battery, one full charge is enough to mow 800 m² (with the model BM46-82V), while with the 2Ah battery it is possible to mow up to 400 m² with one full charge (with model BM37-82V).

The battery is housed in an internal compartment of the motor and can be easily removed to be recharged. In this way, the battery is protected from hits and atmospheric agents.

The combination of 2 batteries allows an autonomy of several consecutive hours, increasing the usability.

H I G H L I G H T S

01. ELECTRIC START



02. 82V BATTERY MOTOR



03. VERTICAL STORAGE



01.
ELECTRIC START

Start the engine simply pushing a button.

02.
82V BATTERY MOTOR

Powerful like a combustion engine, easy like an electric motor.

03.
VERTICAL STORAGE

70% of space saved in your garage.

BM range 82V



Practical and environmentally friendly... without compromises!

- **GUARANTEED POWER**
to mow without compromise compared to an internal combustion engine.
- **OPTIMISED AUTONOMY**
of the battery thanks to the automatic consumption control of the **ECO MODE** and **POWER MODE** system.
- **NO MAINTENANCE**
needed for the 82V Briggs & Stratton motor.
- **LOW ENVIRONMENTAL IMPACT**
for an eco-friendly mowing and a quiet motor.

82V^{MAX} LITHIUM-ION



• GUIDE TO CHOOSE YOUR BATTERY-POWERED GRIN

Model	Blade	Traction	Supplied battery	Battery lifetime m ²	Supplied battery charger	Charging time	Battery life cycles	Reccomended garden size
BM37-82V	37	NO	2Ah	400 m ²	4Ah (4 amps per hour)	30 min.	500\1.000 (1 year ~15-20 cycles for private use)	0-400 m ²
BM46-82V	46	NO	5Ah	800 m ²	4Ah (4 amps per hour)	75 min.	500\1.000 (1 year ~15-20 cycles for private use)	400-800 m ²
BM46A-82V	46	YES PRO with 2 speeds	5Ah	600 m ²	4Ah (4 amps per hour)	75 min.	500\1.000 (1 year ~15-20 cycles for private use)	400-1.200 m ² sloping gardens 800-1.200 m ² with second battery 0-1.200 m ² professional use

GRIN BM37-82V

400 M² WITH ONE FULL CHARGE



FIND OUT MORE!



MOWING
NO GRASS BAG
NO WASTE



GRIN BM37-82V features the Briggs & Stratton electric motor powered by an 82 V Lithium Ion battery.

The 2 Ah 82 V battery allows you to mow up to 400 m² of lawn, under normal conditions, with one full charge.

Built on the proven GRIN chassis, it is equipped with a 1.5KW electric motor that assures incredible performance in tall grass and in difficult conditions, similar to a machine with an internal combustion engine.

The electronics enable the variation of the motor's RPM from 2,600 to 2,900, optimising battery life thanks to automatic power adjustment according to mowing conditions.

The chassis of this machine is the same as a GRIN lawn mower with internal combustion engine.

Thanks to the structural integrity and the motor, it is particularly suitable for tight space and trimming jobs, when it is necessary to combine mowing performance with a reduced noise level, pollutants and engine maintenance.

GRIN BM46-82V

800 M² WITH ONE FULL CHARGE



FIND OUT MORE!



MOWING
NO GRASS BAG
NO WASTE

TESTDRIVE GRIN



GRIN BM46-82V features the Briggs & Stratton electric motor powered by an 82 V Lithium Ion battery.

The 5 Ah and 82V battery allows you to mow up to 800 m² of lawn, under normal conditions, with one full charge.

Built on the proven GRIN chassis, it is equipped with a 1.5KW electric motor that assures incredible performance in tall grass and in difficult conditions, similar to a machine with an internal combustion engine.

The electronics enable the variation of the motor's RPM from 2,600 to 2,900, optimising battery life thanks to automatic power adjustment according to mowing conditions.

The chassis of this machine is the same as a GRIN lawn mower with internal combustion engine and the ENGINE PROTECTION CONE is standard.

Thanks to the structural integrity and the motor, it is widely appreciated by professional gardeners, who need to combine mowing performance with a reduced noise level, pollutants and engine maintenance.

GRIN BM46A-82V

600 M² WITH ONE FULL CHARGE



FIND OUT MORE!



MOWING
NO GRASS BAG
NO WASTE

TESTDRIVE GRIN



GRIN BM46A-82V is a lawn mower with automatic traction equipped with the Briggs & Stratton electric motor powered by an 82V lithium ion battery.

The 5Ah and 82V battery allows you to mow up to 600 m², under normal conditions, with one full charge.

With an additional 5Ah battery, it is possible to mow up to 1.200 m².

The 2 SPEED professional traction in oil bath, in aluminum casing, is reliable and powerful and allows you to adjust the speed according to the conditions of the lawn.

The innovative GRIN design of the traction, mounted on GRIN suspended axles, enables to increase shock resistance and durability. Built on the proven GRIN chassis, with the standard ENGINE PROTECTION CONE, it is equipped with a 1,5 KW electric motor, that assures incredible performance in tall grass and difficult conditions, similar to a machine with internal combustion engine.

The electronics enable the variation of the motor's RPM from 2.600 to 2.900, optimising battery life thanks to automatic power adjustment according to mowing conditions.

Thanks to the structural integrity and the motor, it is widely appreciated by professional gardeners.



Briggs & Stratton PM range

INTERNAL COMBUSTION ENGINE

Professional



The GRIN Briggs & Stratton PM range consists of 4 lawn mowers featuring the patented MOWING – NO GRASS BAG – NO WASTE system designed for professional use. They are powered by the professional BRIGGS & STRATTON 8.50 series internal combustion engine, which is available with both starter cord and electric starter.

Recommended for gardeners, maintainers, cooperatives or demanding private users. Available with mowing width of 46 and 53 cm, the lawn mowers of PM range are equipped with a professional traction to adapt to the different mowing conditions. The wheels with GRIP GRIN tread and MAXI rear diameter assure high performance on uneven terrain.

The engine protection cone, which offers protection from accidental hits on the blade, is standard. The comfort levers combined with the anti-vibration covered handlebar grant more comfort during intensive use.

Representing the evolution in professional maintenance, GRIN's professional range is able to meet the requirements to reduce costs and shorten maintenance time, always granting standard high mowing quality!

Professional HIGHLIGHTS



01. READY START



02. BRIGGS & STRATTON PROFESSIONAL ENGINE



03. PROFESSIONAL TRACTION



04. ENGINE PROTECTION CONE



05. MAXI GRIP GRIN



06. ANTI-VIBRATION HANDLEBAR AND COMFORT LEVERS

01. READY START

Automatic starter to start the engine on the first try.

02. BRIGGS & STRATTON PROFESSIONAL ENGINE

Power and reliability combined with ease of use.

03. PROFESSIONAL TRACTION

Professional with 2 speeds to adapt to different conditions.

04. ENGINE PROTECTION CONE

To minimize impacts on uneven terrain.

05. MAXI GRIP GRIN

To overcome obstacles on uneven terrain.

06. ANTI-VIBRATION HANDLEBAR AND COMFORT LEVERS

For more comfort in case of intensive use.

Briggs & Stratton | PM range

GRIN PM46A



FIND OUT MORE!



MOWING
NO GRASS BAG
NO WASTE

TESTDRIVE GRIN



Built on the proven GRIN chassis, GRIN PM46A is equipped with the powerful and reliable Briggs & Stratton 8.50 series, 190 cc engine with READY START for easy start up.

The 2 SPEED professional traction in oil bath, in aluminum casing, is reliable and powerful and allows you to adjust the speed according to the conditions of the lawn.

The innovative GRIN design of the traction, mounted on GRIN suspended axles, enables to increase shock resistance and durability. **Ideal for professional lawn maintenance, this machine is best suited for difficult conditions.**

Maintainers who use it are astonished by its ability to pulverise grass even when it is tall and wet. It is also suitable for less frequent maintenance.

The 46 cm mowing deck makes it maneuverable in tight space or for trimming jobs.

The reinforced construction, the 3 mm thick mowing deck and the standard ENGINE PROTECTION CONE allow even the most distracted operator to mow rustic lawns. **The quality of the GRIN mowing system combined with the machine's components assure excellent results on well-maintained lawns.**

GRIN PM46A INSTART

ELECTRIC START



FIND OUT MORE!



MOWING
NO GRASS BAG
NO WASTE

TESTDRIVE GRIN



The **INSTART** series of the model PM46A features an electric starter.

Built on the proven **GRIN** chassis, it maintains all the **PM46A** features and is equipped with the powerful and reliable Briggs & Stratton **850 series, 190 cc engine with INSTART system.**

This **innovative engine is powered by a removable Lithium Ion battery** that allows you to start the machine without pulling the cord, but just by pushing on a button.

The **battery, which is fully charged in about 60 minutes by an intelligent charger with diagnostic functions, allows more than 50 starts with one full charge.**

While a partial charge of 10 minutes allows more than 10 starts.

INSTART is a true revolution in the field of lawn mower engines.

GRIN PM53A



FIND OUT MORE!



**MOWING
NO GRASS BAG
NO WASTE**

TESTDRIVE GRIN



Built on the proven GRIN chassis, GRIN PM53A is equipped with the powerful and reliable Briggs & Stratton 850 series, 190 cc engine with READY START for easy start up.

The 2 SPEED professional traction in oil bath, in aluminum casing, is reliable and powerful and allows you to adjust the speed according to the conditions of the lawn.

The innovative GRIN design of the traction, mounted on GRIN suspended axles, enables to increase shock resistance and durability. Ideal for professional lawn maintenance, this machine is best suited for difficult conditions.

Maintainers who use it are astonished by its ability to pulverise grass even when it is tall and wet. It is also suitable for less frequent maintenance.

The 53 cm mowing deck makes it suitable for large spaces, while assuring easy maneuverability even in smaller spaces.

GRIN PM53A INSTART

ELECTRIC START



FIND OUT MORE!



MOWING
NO GRASS BAG
NO WASTE

TESTDRIVE GRIN



The **INSTART** series of the model PM53A features an electric starter.

Built on the proven **GRIN** chassis, it maintains all the PM53A features and is equipped with the powerful and reliable Briggs & Stratton **850 series, 190 cc engine with INSTART system.**

This innovative engine is powered by a removable **Lithium Ion battery** that allows you to start the machine without pulling the cord, but just by pushing on a button.

The battery, which is fully charged in about 60 minutes by an intelligent charger with diagnostic functions, allows more than 50 starts with one full charge.

While a partial charge of 10 minutes allows more than 10 starts.

INSTART is a true revolution in the field of lawn mower engines.



Kawasaki PM range

INTERNAL COMBUSTION ENGINE

Professional



The GRIN PM KAWASAKI range consists of 2 lawn mowers featuring the patented MOWING – NO GRASS BAG – NO WASTE system **designed for professional use.** They are **powered by the professional KAWASAKI FJ180V KAI motor, equipped with pressurised lubrication to mow on slopes.**

Recommended for gardeners, maintainers, cooperatives or demanding private users.

Available with mowing width of 53 cm, the lawn mowers of PM range are **equipped with a professional traction to adapt to the different mowing conditions.**

The wheels with GRIP GRIN tread and MAXI rear diameter assure high performance on uneven terrain.

The engine protection cone, which offers protection from accidental hits on the blade, is standard. The comfort levers combined with the anti-vibration covered handlebar grant more comfort during intensive use.

Representing the evolution in professional maintenance, GRIN's professional range is able to meet the requirements to reduce costs and shorten maintenance time, always granting standard high mowing quality!

Professional HIGHLIGHTS



01. KAWASAKI PROFESSIONAL ENGINE

Designed for the most demanding professional.

02. PRESSURISED LUBRICATION ON SLOPES

To mow even on slopes over 20°.

03. PROFESSIONAL TRACTION

Professional with 2 speeds to adapt to different conditions.

04. ENGINE PROTECTION CONE

To minimize impacts on uneven terrain.

05. MAXI GRIP GRIN

To overcome obstacles on uneven terrain.

06. ANTI-VIBRATION HANDLEBAR AND COMFORT LEVERS

For more comfort in case of intensive use.

Kawasaki | PM range

GRIN PM53A KW

ENGINE FOR SLOPES > 20°



FIND OUT MORE!



MOWING
NO GRASS BAG
NO WASTE

TESTDRIVE GRIN



Built on the proven **GRIN chassis**, GRIN PM53A KW is equipped with the most appreciated **Kawasaki FJ180V KAI, 179 cc, professional engine**. It features a pressurised lubrication system to mow on slopes without facing lubrication problems.

The **2 SPEED professional traction in oil bath**, in aluminum casing, is **reliable and powerful** and allows you to adjust the speed according to the conditions of the lawn.

The innovative **GRIN design of the traction**, mounted on **GRIN suspended axles**, enables to increase shock resistance and durability.

Ideal for professional lawn maintenance, this machine is **best suited for difficult conditions**. Maintainers who use it are astonished by its ability to pulverise grass even when it is tall and wet. It is also suitable for less frequent maintenance.

The **53 cm mowing deck** makes it suitable for large spaces, while assuring easy maneuverability even in smaller spaces.

GRIN SPM53A KW

ENGINE FOR SLOPES > 20°



FIND OUT MORE!



MOWING
NO GRASS BAG
NO WASTE

TESTDRIVE GRIN



GRIN SPM53A KW is a 3-wheeled machine, with off-centered engine, ideal for maintenance in tall grass and on slopes.

The innovative **Grin HD bridge frame** allows to fit the professional KAWASAKI engine off-centre.

The **lockable pivoting front wheel**, the **GRIP GRIN MAXI** rear wheels and the excellent weight balance make this machine agile and easy to maneuver in tight space, on uneven terrain and on slopes.

The 3-wheeled structure facilitates mowing near trees or other obstacles.

The professional KAWASAKI engine is equipped with a pressurised lubrication system to mow on slopes without facing lubrication problems.

Ideal for professional use in tall grass, it is best suited for **difficult lawns with different mowing conditions**, e.g. from rustic lawn, not often maintained to regularly maintained areas.

Summary data sheet



MODEL	RECOMMENDED FOR			MOWING WIDTH	WEIGHT	(Length x Width x Height)	(Length x Width x Height)	ENGINE			
	M ²	SLOPE	USER			DIMENSIONS FOLDED	DIMENSIONS IN OPERATION	POWER SOURCE	ENGINE	START	VERTICAL STORAGE
EM37	0-400	0-10°	HobbyPRO	37 cm	20 kg	820x420 x370	1150x420 x1030	corded electric	electric 220 Volt Power 1.600 Watt	electric with push button	yes
HM37	0-400	0-10°	HobbyPRO	37 cm	25 kg	800x420 x420	1250x420 x1000	fuel	Briggs & Stratton 6.75 Ready Start 4-stroke - 163 cc MOW N'STOW	starter cord	yes
HM46	400-800	0-10°	HobbyPRO	46 cm	27 kg	800x520 x420	1250x520 x1000	fuel	Briggs & Stratton 6.75 Ready Start 4-stroke - 163 cc MOW N'STOW	starter cord	yes
HM46 IS	400-800	0-10°	HobbyPRO	46 cm	28 kg	800x520 x420	1250x520 x1000	fuel	Briggs & Stratton 6.75 - INSTART 4-stroke - 163 cc MOW N'STOW	electric with push button	yes
HM46A	800-1.200	0-20°	HobbyPRO	46 cm	32 kg	800x520 x420	1250x520 x1000	fuel	Briggs & Stratton 6.75 Ready Start 4-stroke - 163 cc MOW N'STOW	starter cord	yes
HM46A IS	800-1.200	0-20°	HobbyPRO	46 cm	33 kg	800x520 x420	1250x520 x1000	fuel	Briggs & Stratton 6.75 - INSTART 4-stroke - 163 cc MOW N'STOW	electric with push button	yes
HM53A	800-1.200	0-20°	HobbyPRO	53 cm	34 kg	900x600 x450	1350x600 x1000	fuel	Briggs & Stratton 6.75 Ready Start 4-stroke - 163 cc MOW N'STOW	starter cord	yes
HM53A IS	800-1.200	0-20°	HobbyPRO	53 cm	35 kg	900x600 x450	1350x600 x1000	fuel	Briggs & Stratton 6.75 - INSTART 4-stroke - 163 cc MOW N'STOW	electric with push button	yes
BM37-82V	0-400	0-10°	HobbyPRO	37 cm	23 kg without battery	800x420 x420	1250x420 x1000	battery	Briggs & Stratton 82V - Lithium ION	electric with push button	yes
BM46-82V	400-800	0-10°	HobbyPRO	46 cm	25 kg without battery	800x520 x420	1250x520 x1000	battery	Briggs & Stratton 82V - Lithium ION	electric with push button	yes
BM46A-82V	800-1.200	0-30°	Professional	46 cm	33 kg without battery	800x520 x420	1250x520 x1000	battery	Briggs & Stratton 82V - Lithium ION	electric with push button	yes
PM46A	800-1.200	0-20°	Professional	46 cm	37 kg	800x520 x420	1250x520 x1000	fuel	Briggs & Stratton 8.50 professional OHV Ready Start 4-stroke - 190 cc	starter cord	no
PM46A IS	800-1.200	0-20°	Professional	46 cm	38 kg	800x520 x420	1250x520 x1000	fuel	Briggs & Stratton 8.50 professional OHV INSTART 4-stroke - 190 cc	electric with push button	no
PM53A	1.200-3.000	0-20°	Professional	53 cm	39 kg	900x600 x450	1350x600 x1000	fuel	Briggs & Stratton 8.50 professional OHV Ready Start 4-stroke - 190 cc	starter cord	no
PM53A IS	1.200-3.000	0-20°	Professional	53 cm	40 kg	900x600 x450	1350x600 x1000	fuel	Briggs & Stratton 8.50 professional OHV INSTART 4-stroke - 190 cc	electric with push button	no
PM53A KW	1.200-3.000	0-30°	Professional	53 cm	47 kg	900x600 x450	1350x600 x1000	fuel	Kawasaki Fj180V KAI - 4-stroke with pressurised lubrication to mow on slopes - 179 cc	starter cord	no
SPM53A KW	1.200-3.000	0-30°	Professional	53 cm	59 kg	1050x600 x550	1450x600 x550	fuel	Kawasaki Fj180V KAI - 4-stroke with pressurised lubrication to mow on slopes - 179 cc	starter cord	no



MOWING HEIGHT			WHEELS					HANDLEBAR		ENGINE PROTECTION CONE
REGULATION	MOWING HEIGHTS	MOWING HEIGHTS (mm)	MATERIAL	SLIDING	TREAD	FRONT DIAMETER	REAR DIAMETER	FOLDABLE	QUICK REGULATION	
centralised	4	30-60 mm	steel	double ball bearing	sculpted	115	115	yes	yes	no
centralised	4	35-70 mm	steel	double ball bearing	Grip Grin	181	181	yes	anti-vibration	optional
centralised	4	35-70 mm	steel	double ball bearing	Grip Grin	181	181	yes	anti-vibration	optional
centralised	4	35-70 mm	steel	double ball bearing	Grip Grin	181	181	yes	anti-vibration	optional
centralised	4	35-70 mm	steel	double ball bearing	Grip Grin	181	235	yes	anti-vibration	optional
centralised	4	35-70 mm	steel	double ball bearing	Grip Grin	181	235	yes	anti-vibration	optional
centralised	4	35-70 mm	steel	double ball bearing	Grip Grin	181	235	yes	anti-vibration	optional
centralised	4	35-70 mm	steel	double ball bearing	Grip Grin	181	235	yes	anti-vibration	optional
centralised	4	35-70 mm	steel	double ball bearing	Grip Grin	181	181	yes	anti-vibration	optional
centralised	4	35-70 mm	steel	double ball bearing	Grip Grin	181	181	yes	anti-vibration	yes
centralised	4	35-70 mm	steel	double ball bearing	Grip Grin	181	281	yes	anti-vibration	yes
centralised	4	35-70 mm	steel	double ball bearing	Grip Grin	181	281	yes	anti-vibration	yes
centralised	4	35-70 mm	steel	double ball bearing	Grip Grin	181	281	yes	anti-vibration	yes
centralised	4	35-70 mm	steel	double ball bearing	Grip Grin	181	281	yes	anti-vibration	yes
centralised	4	35-70 mm	steel	double ball bearing	Grip Grin	181	281	yes	anti-vibration	yes
centralised	4	35-70 mm	steel	double ball bearing	Grip Grin	181	281	yes	anti-vibration	yes
front wheel	3	55-96 mm	steel	double ball bearing	Grip Grin	181	281	yes	anti-vibration	yes

6. THE GRIN RANGE



RIDE-ON LAWN MOWER

RM 1 2 0

Professional

Grin RM 120 is a ride-on lawn mower with a patented, unique and innovative mowing deck:

- **Three separate GRIN mowing decks** to optimize the patented mowing system.
- **Sealed deck**, to protect and preserve the mowing system.
- **Drive belts** shielded from dirt, but easily accessible for maintenance.
- **Sound insulation**, which significantly reduce noise level.

Thanks to this mowing deck, **the pulverization quality, the high performance in difficult conditions and the result on uneven ground remain unchanged** and are always guaranteed by the GRIN mowing system without grass bag.

RM120 is a professional ride-on mower that combines the ease of zero-turn with the simplicity of joystick control.

The three-wheeled structure, with the swiveling front wheels, **allows not only a safe work but also to mow easily near obstacles.**

RM120 is equipped with a 120 cm mowing deck and a 20 hp internal combustion engine.

In addition, belongs to the standard equipment:

- **HEIGHT QUICK ADJUSTMENT** • **SPEED SETTING**
- **MULTIFUNCTIONAL DISPLAY** • **ELECTRONIC SETTING OF THE MOWING HEIGHT**

Professional HIGHLIGHTS

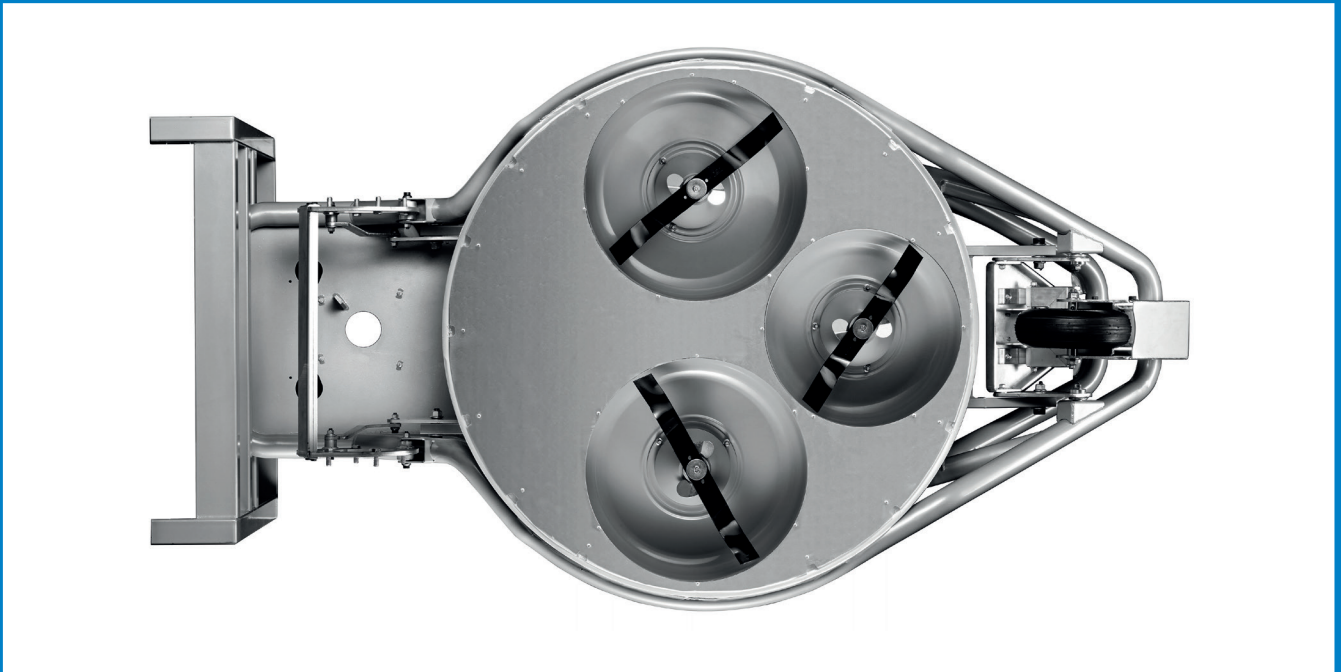

THE **GRIN MOWING DECK** : **UNIQUE AND INNOVATIVE.**



THE **EASE OF ZERO-TURN** WITH THE **SIMPLICITY OF JOYSTICK CONTROL.**

RM 1 2 0

6. THE GRIN RANGE



**THE GRIN PATENTED MOWING DECK
GUARANTEES HIGH QUALITY PULVERIZATION EVEN IN TALL GRASS.**



FIND OUT MORE!

TECHNICAL SPECIFICATIONS		RM 1 2 0	
ENGINE			
Model	B&S Series8 Commercial Series 44T8		
Fuel	Gasoline		
Power / displacement	20HP / 724cc		
Number of Cylinders	2		
Equipment	High pressure lubrication system/ Cyclonic Air Filter / Fuel filter		
Fuel tank capacity	35 L		
HYDRAULIC SYSTEM			
Pumps	1 supply pump, N.2 variable displacement axial piston pump, 1 gear pump		
Wheels actuators	N.2 orbital motor 320cc		
Brakes	N.2 Hydraulic negative brakes		
Brake release system	Accumulator 0.35L for emergency brake release		
Drive wheels	2WD		
Maximum speed	12 Km/h		
Driving system	Zero turn system with hydraulic joystick - Adjustable top speed limiter "Quick lifting" button		
Cutting height regulation	Hydraulic		
SEAT			
Model	Shuttle 99R with adjustable armrests		
WHEELS			
"Garden" real wheels	Turf Smart 20 x 8.00 - 10		
"Clawed" real wheels	Super Lug 20 x 8.00 - 10		
Front wheel	Straight Rib 11 x 4.00 - 5		
ELECTRICAL SYSTEM			
Battery	12 V / 30 Ah (300 A)		
Instrument Panel	"Smart view" Multifunction Display: Hour counter – Cutting System Status – Cutting Height Hydraulic oil and Gasoline level indicators		
Alarms and indicator lights	Engine oil pressure – parking brake – battery – Human presence sensor		
MOWING SYSTEM			
Special feature	Patented Grin "Mowing, no grass bag, no waste" system		
Mowing deck	120cm / 3 separate blades Patented closed cutting system with noise reduction Mowing deck cleaning system		
Cutting height regulation	Hydraulic cutting height regulation from 5 to 15cm		
WEIGHT AND DIMENSION			
Dry weight	485 Kg		
Length / Width / Height	238 x 135 x 132 cm		
RECOMMENDED FOR	PROFESSIONAL USE for maintenance of large surfaces.		



BLOCH range

INTERNAL COMBUSTION ENGINE

HobbyPRO

Professional



The BLOCH range consists of 2 shredders for demanding private and professional users, who are looking for high-quality products with an effective pruning shredding system in all situations, without giving up compact dimensions and easy handling.

Powered by high-performance, professional Briggs & Stratton engines, they are equipped with a comfortable electric starter that grants an immediate and effortless start. The start cord is also available in case of necessity.

The quality of chippings is guaranteed by the GRIN cutting system and the steel frame grants the reliability and durability of these products. Innovative, technical solutions, the ergonomic design and the weight distribution allow these machines to be moved inside the garden without effort or to be transported easily by car or in a van.

Each component was developed to grant the highest user convenience and security.

H I G H L I G H T S

01. STEEL FRAME



02. GRIN CUTTING DISK



03. EASY HANDLING



01. STEEL FRAME

The high-quality steel frame grants durability, professional performances and safety of the user.

Both the hopper and the chippings discharge system allow the material to be quickly processed, minimizing the possibility of blocking the machine.

02. GRIN CUTTING DISK

The GRIN cutting system, with blades and flails, is made of steel and grants fine chippings even of difficult pruning, for example if humid and fibrous.

The perfect combination of blades and counter blades is the core of the cutting system; the steel flails help process the material and then discharge it quickly.

03. EASY HANDLING

The machines of the BIOCH range are developed to be quickly and easily moved. The perfect weight balance, the lowered center of gravity, the wheels with double ball bearing and bigger diameter and the practical handles allow the machines to be moved without effort, also on uneven terrain.

BIOCH range

GRIN BIOCH50

ELECTRIC START



GRIN BIOCH50 is the ideal shredder for demanding private users that need to chop the pruning of hedges, orchards and vegetable gardens up to diameters of 50-55 mm.

Built on a robust steel frame, it is equipped with the powerful and reliable Briggs & Stratton XR PROFESSIONAL Series, 208 cc engine with electric starter.

The GRIN chopping system with a 280 mm disk, with 2 blades and 8 flails, allows you to finely and quickly process all kind of pruning to transform it into excellent chippings for your garden. The steel structure grants durability and performance even by intensive use and it is developed to be very handy thanks to the big GRIP GRIN run flat wheels and the practical transport handle. The feed hopper is equipped with a quick opening to clean the cutting system and for an easy transport even by car. The wide and high hopper allows the operator to load a good quantity of material in complete safety.



INTERNAL COMBUSTION ENGINE

RECOMMENDED FOR DIAMETER

50 mm

RECOMMENDED FOR CHOPPING

Pruning of hedges, orchards and vegetable gardens.

TECHNICAL SPECIFICATIONS

CUTTING SYSTEM	GRIN cutting system with 6 mm thick disk and diameter of 280 mm, with 2 blades and 8 flails
BLADES	100 mm in high strength , hardened steel
WHEELS	GRIP GRIN run flat tires , in steel and with double ball bearing and MAXI diameter
STRUCTURE	Powder coated steel
ENGINE	Briggs & Stratton XR Professional 4-stroke, 208 cc engine
START	Electric (starter cord available if necessary)
WEIGHT	71 Kg
DISCHARGE SYSTEM	Fixed - in steel
HOPPER	Quick opening system for cleaning and transport
TRANSMISSION	V-belt
HOURLY OUTPUT	2 - 3 cubic meters per hour depending on the processed material



GRIN BIOCH70

ELECTRIC START



GRIN BIOCH70 is the ideal shredder for gardeners, farmers and demanding private users who need a powerful machine with compact dimensions and low weight to chop pruning up to diameters of 70-75 mm, also suitable for fibrous wood such as olive trees and palms.

Build on a robust steel frame, it is equipped with the powerful and reliable Briggs & Stratton XR 1450 Series, 306 cc engine with electric starter.

The GRIN chopping system with a 340 mm disk, with 2 blades and 12 flails, allows you to finely and quickly process all kind of pruning, even the most fibrous one, and transform it into excellent chippings. The steel structure grants durability and performance even by intensive use and it is developed to be very handy thanks to the big GRIP GRIN run flat wheels and the practical transport handle. The wide and high hopper allows the loading of a good quantity of material and the safety of the user. The 360°swiveling discharge chute with quick adjustable system is very wide and allows you to discharge the processed material directly onto a van or a trailer.



INTERNAL COMBUSTION ENGINE

RECOMMENDED FOR DIAMETER

70 mm

RECOMMENDED FOR CHOPPING

Purning of wood with many leaves (also olive trees and palms).

TECHNICAL SPECIFICATIONS

CUTTING SYSTEM	GRIN cutting system with 10 mm thick disk and diameter of 340 mm, with 2 blades and 12 flails
BLADES	150 mm in high strength , hardened steel
WHEELS	GRIP GRIN run flat tires , in steel and with double ball bearing and MAXI diameter
STRUCTURE	Powder coated steel
ENGINE	Briggs & Stratton XR 1450 4-stroke, 306 cc engine
START	Electric (starter cord available if necessary)
WEIGHT	135 kg
DISCHARGE SYSTEM	Swiveling at 360° with quick adjustable system - in steel
HOPPER	Removable
TRANSMISSION	Double V-belt
HOURLY OUTPUT	4 - 6 cubic meters per hour depending on the processed material







7.

GRIN IS ALWAYS BY YOUR SIDE

The GRIN company ·



The GRIN company

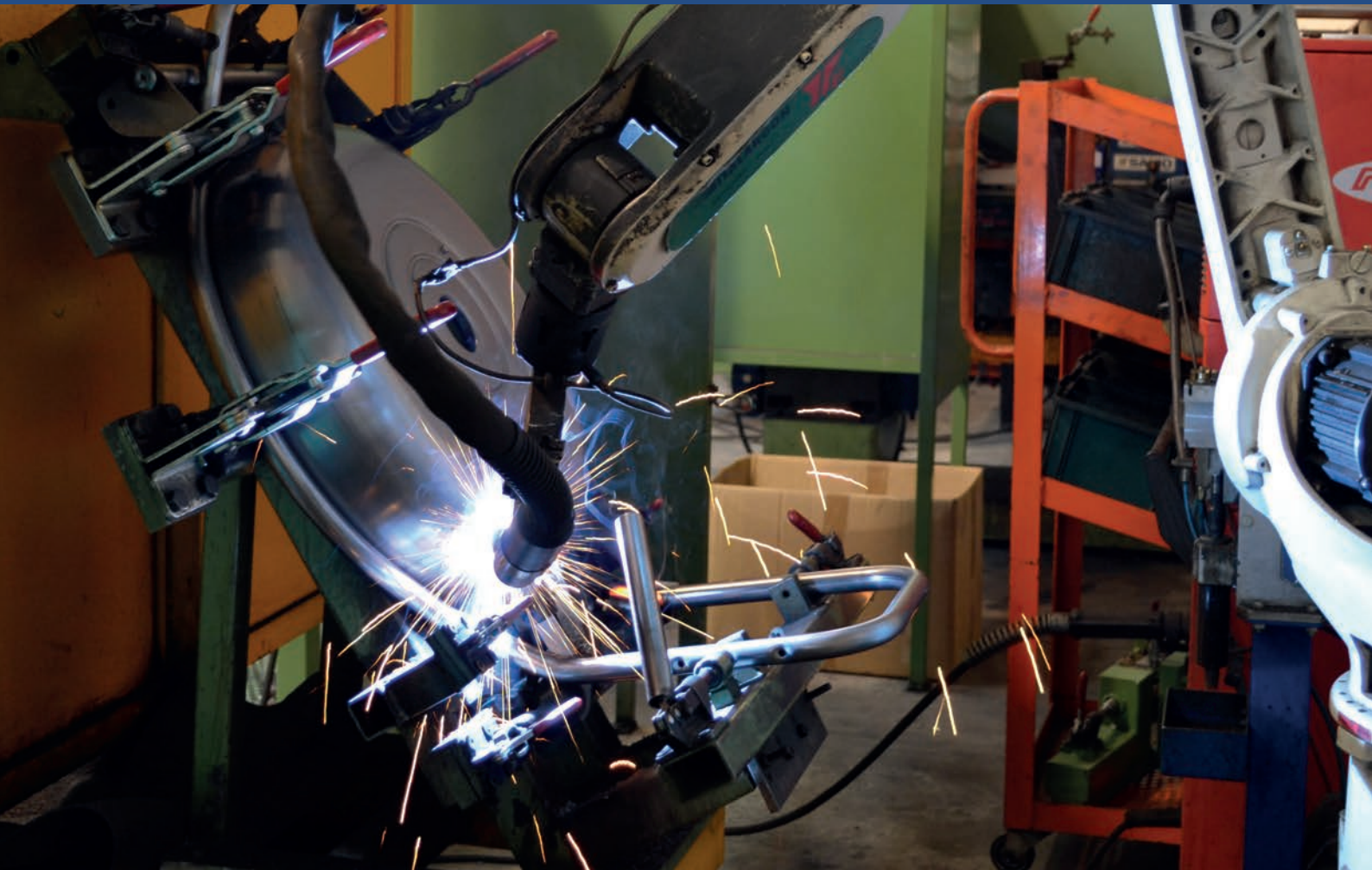

GRIN srl was founded in 2005 around the patented mowing system: MOWING – NO GRASS BAG - NO WASTE.

With headquarters in Sirtori, Lecco province, famous for the mechanical engineering industry, GRIN srl has grown thanks to the passion and years of expertise within the lawn mowing sector.

The first years were dedicated to the development of a highly innovative range of lawn mowers produced in Italy.

Innovation and quality are the groundstones of GRIN philosophy. Therefore, the company itself carries out all development steps, the production and the assembly.

Over 95% of the components are MADE IN ITALY and most of them are produced directly by GRIN.

During these years, the GRIN project has grown and developed in the main **European markets**. This led to the opening of the branch **GRIN FRANCE in La Verpillière**, near Lyon, and to the launch of the countries **BELGIUM and the NETHERLANDS**, as well as many collaborations with international distributors.



#changeyourperspective

HEADQUARTER
and BRANCH



GRIN ITALY

📍 Via delle Industrie, 13
23896 Sirtori (Lc) - Italia

☎ +39 039.95.51.98

📱 @grinsrl

📷 mygrin_ita



GRIN FRANCE

📍 Z.I. Le Grand Planot 38290
La Verpillière - France

☎ +33 (0)4.13.68.09.16

📱 @grinfr

📷 mygrin_fra

COUNTRY



GRIN BELGIUM

☎ +32 (0)473.13.45.05

📱 @grinbelgie

📷 mygrin_bel



GRIN NETHERLAND

☎ +31 (0)6.21.64.39.99

📱 @mygrinnl

📷 mygrin_nld

✉ info@mygrin.it



More than 750 specialised and selected dealers.



CHOOSE YOUR DEALER ON WWW.MYGRIN.EU

#changeyourperspective

GRIN ADVISES YOU: